



pvsolars.net

ФИН КОНСУЛТ ПРИМ ЕООД, Булстат 202252315
тел: 0896 82 50 22, email: pvsolarsnet@gmail.com
гр. Съединение 4190, обл. Пловдив, Индустриална Зона

Оферта с включен монтаж

Соларна система Huawei 6,5 kW без батерия

ОБЕКТ: Соларна система, жилищна сграда, покрив					
№	описание на материалните средства, строително-монтажни работи	мярка	колич.	ед. цена в ЛВ С ДДС	Общо ЛВ С ДДС
1	Фотоволтаични панели 545W JA SOLAR	брой	12	429	5148
2	Соларен инвертор Huawei SUN2000-6KTL-L1 монофазен	брой	1	3595	3595
3	Huawei DTSU666-H ограничител на изходящата енергия монофазен	брой	1	319	319
4	Алуминиева конструкция за покрив за 12 броя панели	брой	1	1449	1449
5	Соларен кабел, MC4 конектори, табла за защита	брой	1	1193	1193
6	Монтаж на конструкция и фотоволтаични панели Окабеляване на фотоволтаичната система Монтаж на Инвертор и табла защита Настройка и пускане в експлоатация	включени	1	3270	3270
Дата: 01.05.2023				ОБЩО ЛВ С ДДС	14 974 ЛВ

ФИН КОНСУЛТ ПРИМ ЕООД, Булстат 202252315
тел: 0896 82 50 22, email: pvsolarsnet@gmail.com
гр. Съединение 4190, обл. Пловдив, Индустриална Зона

Технически характеристики на включените компоненти в системата

Фотоволтаични модули

- Ефективност на модула 21,1% \geq 20%
- Продуктова гаранция 12 години \geq 12 години
- Деградация първа година \leq 1% \leq 2%
- Линейна деградация за:
 - еднолицеви модули \leq 0,5% на година \leq 0,6% на година,

Инвертор

- Ефективност на инвертора (European weighted efficiency) 97,8% \geq 96%
- Смущения от хармоници THD \leq 3% \leq 3%
- Продуктова гаранция 10 години \geq 10 години
- Наличие на устройство, което ограничава връщане на електроенергия в мрежата съвместимо с инвертора или вградена такава функция на самият инвертор- Huawei Smart Meter

Системи за съхранение

- НЯМА

Конструкция

- Материалите и крепежните елементи, използвани в конструкцията за монтаж на модулите са алуминий и неръждаема стомана, които са нискокорозионни материали и не повишават степента на корозия, когато са монтирани заедно в масив или когато са монтирани върху повърхността на основна конструкция
- Продуктова гаранция 10 години \geq 10 години

Harvest the Sunshine

DEEP BLUE 3.0

Mono

550W MBB Half-cell Module
JAM72S30 525-550/MR Series

Introduction

Assembled with 11BB PERC cells, the half-cell configuration of the modules offers the advantages of higher power output, better temperature-dependent performance, reduced shading effect on the energy generation, lower risk of hot spot, as well as enhanced tolerance for mechanical loading.



Higher output power



Lower LCOE



Less shading and lower resistive loss



Better mechanical loading tolerance

Superior Warranty

- 12-year product warranty
- 25-year linear power output warranty

0.55% Annual Degradation
Over 25 years

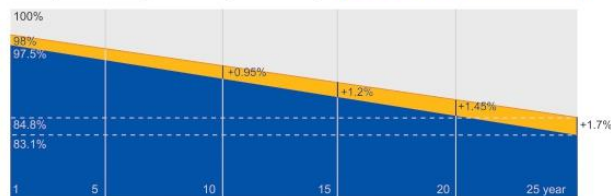

■ New linear power warranty ■ Standard module linear power warranty

Comprehensive Certificates

- IEC 61215, IEC 61730, UL 61215, UL 61730
- ISO 9001: 2015 Quality management systems
- ISO 14001: 2015 Environmental management systems
- ISO 45001: 2018 Occupational health and safety management systems
- IEC TS 62941: 2016 Terrestrial photovoltaic (PV) modules – Guidelines for increased confidence in PV module design qualification and type approval



JASOLAR

www.jasolar.com

Specifications subject to technical changes and tests.
JA Solar reserves the right of final interpretation.



ФИН КОНСУЛТ ПРИМ ЕООД, Булстат 202252315
тел: 0896 82 50 22, email: pvsolarsnet@gmail.com
гр. Съединение 4190, обл. Пловдив, Индустриална Зона

MECHANICAL DIAGRAMS

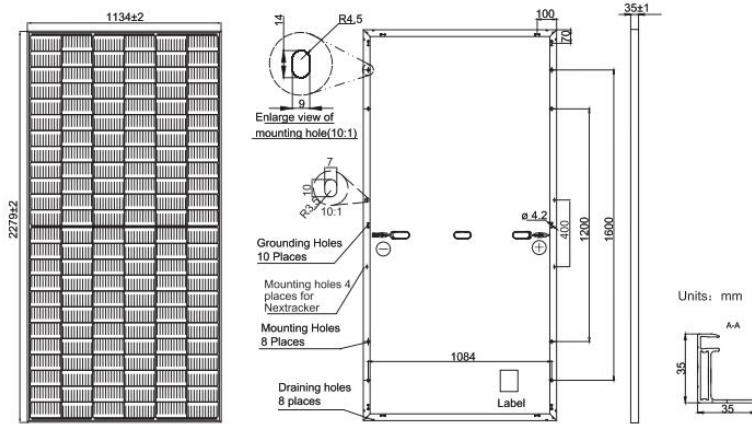

Remark: customized frame color and cable length available upon request

SPECIFICATIONS

Cell	Mono
Weight	28.6kg±3%
Dimensions	2279±2mm×1134±2mm×35±1mm
Cable Cross Section Size	4mm ² (IEC) , 12 AWG(UL)
No. of cells	144(6×24)
Junction Box	IP68, 3 diodes
Connector	QC 4.10(1000V) QC 4.10-35(1500V)
Cable Length (Including Connector)	Portrait: 300mm(+)/400mm(-); Landscape: 1300mm(+)/1300mm(-)
Packaging Configuration	31pcs/Pallet, 620pcs/40ft Container

ELECTRICAL PARAMETERS AT STC

TYPE	JAM72S30 -525/MR	JAM72S30 -530/MR	JAM72S30 -535/MR	JAM72S30 -540/MR	JAM72S30 -545/MR	JAM72S30 -550/MR
Rated Maximum Power(Pmax) [W]	525	530	535	540	545	550
Open Circuit Voltage(Voc) [V]	49.15	49.30	49.45	49.60	49.75	49.90
Maximum Power Voltage(Vmp) [V]	41.15	41.31	41.47	41.64	41.80	41.96
Short Circuit Current(Isc) [A]	13.65	13.72	13.79	13.86	13.93	14.00
Maximum Power Current(Imp) [A]	12.76	12.83	12.90	12.97	13.04	13.11
Module Efficiency [%]	20.3	20.5	20.7	20.9	21.1	21.3
Power Tolerance	0~+5W					
Temperature Coefficient of Isc(α _{Isc})	+0.045%/°C					
Temperature Coefficient of Voc(β _{Voc})	-0.275%/°C					
Temperature Coefficient of Pmax(γ _{Pmp})	-0.350%/°C					
STC	Irradiance 1000W/m ² , cell temperature 25°C, AM1.5G					

Remark: Electrical data in this catalog do not refer to a single module and they are not part of the offer.They only serve for comparison among different module types.

ELECTRICAL PARAMETERS AT NOCT

TYPE	JAM72S30 -525/MR	JAM72S30 -530/MR	JAM72S30 -535/MR	JAM72S30 -540/MR	JAM72S30 -545/MR	JAM72S30 -550/MR
Rated Max Power(Pmax) [W]	397	401	405	408	412	416
Open Circuit Voltage(Voc) [V]	46.05	46.18	46.31	46.43	46.55	46.68
Max Power Voltage(Vmp) [V]	38.36	38.57	38.78	38.99	39.20	39.43
Short Circuit Current(Isc) [A]	10.97	11.01	11.05	11.09	11.13	11.17
Max Power Current(Imp) [A]	10.35	10.39	10.43	10.47	10.51	10.55
NOCT	Irradiance 800W/m ² , ambient temperature 20°C, wind speed 1m/s, AM1.5G					

*For NexTracker installations, Maximum Static Load, Front is 2400Pa while Maximum Static Load, Back is 2400Pa.

OPERATING CONDITIONS

Maximum System Voltage	1000V/1500V DC
Operating Temperature	-40°C~+85°C
Maximum Series Fuse Rating	25A
Maximum Static Load,Front*	5400Pa(112lb/ft ²)
Maximum Static Load,Back*	2400Pa(50lb/ft ²)
NOCT	45±2°C
Safety Class	Class II
Fire Performance	UL Type 1

CHARACTERISTICS

Current-Voltage Curve JAM72S30-540/MR

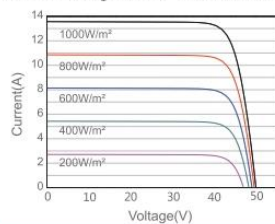

Power-Voltage Curve JAM72S30-540/MR

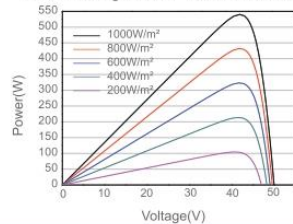

Current-Voltage Curve JAM72S30-540/MR

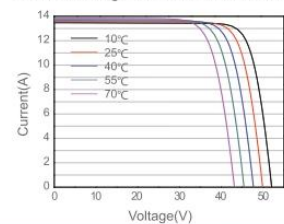

Premium Cells, Premium Modules

Version No. : Global_EN_20201207A

Smart Energy Center



Active Safety

AI Powered
Active Arcing Protection



Higher Yields

Up to 30% More
Energy with Optimizer



2x POWER Battery Ready

5KW AC Output plus
5KW Battery Charge

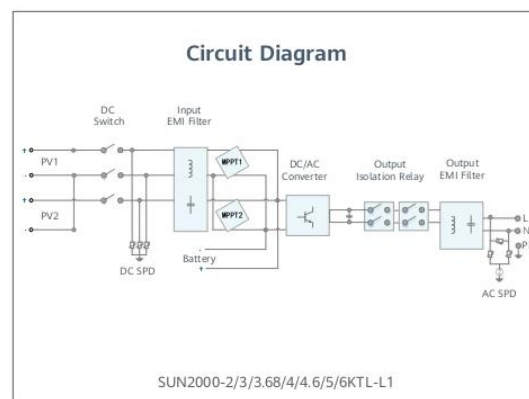
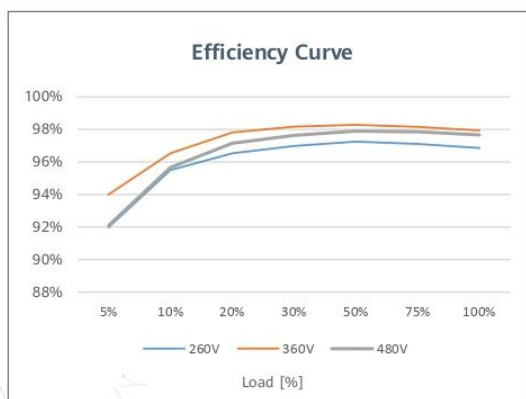

SOLAR.HUAWEI.COM

ФИН КОНСУЛТ ПРИМ ЕООД, Булстат 202252315
тел: 0896 82 50 22, email: pvsolarsnet@gmail.com
гр. Съединение 4190, обл. Пловдив, Индустриална Зона

SUN2000-2/3/3.68/4/4.6/5/6KTL-L1
Technical Specification

Technical Specification	SUN2000 -2KTL-L1	SUN2000 -3KTL-L1	SUN2000 -4KTL-L1	SUN2000 -4.6KTL-L1	SUN2000 -5KTL-L1	SUN2000 -6KTL-L1 ¹
Efficiency						
Max. efficiency	98.2 %	98.3 %	98.4 %	98.4 %	98.4 %	98.4 %
European weighted efficiency	96.7 %	97.3 %	97.5 %	97.5 %	97.7 %	97.8 %
Input (PV)						
Recommended max. PV power ²	3,000 Wp	4,500 Wp	6,000 Wp	6,900 Wp	7,500 Wp	9,000 Wp
Max. input voltage	600 V ³					
Start-up voltage	100 V					
MPPT operating voltage range	90 V - 560 V ³					
Rated input voltage	360 V					
Max. input current per MPPT	12.5 A					
Max. short-circuit current	18 A					
Number of MPP trackers	2					
Max. number of inputs	2					
Input (DC Battery)						
Compatible Battery	LG Chem RESU 7H_R / 10H_R					
Operating voltage range	350 ~ 450 Vdc					
Max operating current	10 A @7H_R / 15 A @10H_R					
Max charge power	3,500 W @7H_R / 5,000 W @10H_R					
Max discharge Power @7H_R	2,200 W	3,300 W	3,500 W	3,500 W	3,500 W	3,500 W
Max discharge Power @10H_R	2,200 W	3,300 W	4,400 W	4,600 W	5,000 W	5,000 W
Compatible Battery	HUAWEI PowerMate ESS Battery 5kWh - 30kWh ¹					
Operating voltage range	350 ~ 560 Vdc					
Max operating current	15 A					
Max charge / discharge Power	5,000 W ⁴					
Output						
Grid connection	Single phase					
Rated output power	2,000 W	3,000 W	4,000 W	4,600 W	4,990 W ⁵	6,000 W
Max. apparent power	2,200 VA	3,300 VA	4,400 VA	4,600 VA	4,990 VA ⁶	6,000 VA
Rated output voltage	220 V / 230 V / 240 V					
Rated AC grid frequency	50 Hz / 60 Hz					
Max. output current	10 A	15 A	20 A	20.9 A	21.7 A ⁷	27 A
Adjustable power factor	0.8 leading ... 0.8 lagging					
Max. total harmonic distortion	≤ 3 %					
Backup power output	Yes (via Backup Box-5000 ¹)					
Protection & Feature						
Anti-islanding protection	Yes					
DC reverse polarity protection	Yes					
Insulation monitoring	Yes					
DC surge protection	Yes, compatible with TYPE II protection class according to EN/IEC 61643-11					
AC surge protection	Yes, compatible with TYPE II protection class according to EN/IEC 61643-11					
Residual current monitoring	Yes					
AC overcurrent protection	Yes					
AC short-circuit protection	Yes					
AC overvoltage protection	Yes					
Over-heat protection	Yes					
Arc fault protection	Yes					
Battery reverse charging from grid	Yes					
General Data						
Operating temperature range	-25 ~ +60 °C (Derating above 45°C @ Rated output power)					
Relative operating humidity	0 %RH ~ 100 %RH					
Operating altitude	0 ~ 4,000 m (Derating above 2,000 m)					
Cooling	Natural convection					
Display	LED indicators; integrated WLAN + FusionSolar APP					
Communication	RS485, WLAN via inverter built-in WLAN module Ethernet via Smart Dongle-WLAN-FE (Optional); 4G / 3G / 2G via Smart Dongle-4G (Optional)					
Weight (incl. mounting bracket)	12.3 kg (27.1 lb)					
Dimension (incl. mounting bracket)	365mm * 365mm * 140 mm (14.4 x 14.4 x 5.5 inch)					
Degree of protection	IP65					
Optimizer Compatibility						
DC MBUS compatible optimizer	SUN2000-450W-P					
Standard Compliance (more available upon request)						
Safety	EN/IEC 62109-1, EN/IEC 62109-2					
Grid connection standards	G98, G99, EN 50549-1, CEI 0-21, VDE-AR-N-4105, AS 4777, C10/11, ABNT, UTE C15-712, RD 1699, TOR D4, IEC61727, IEC62116					

¹ Available in 2020 Q3.

² Inverter max input PV power is 10,000 Wp when long strings are designed and fully connected with SUN2000-450W-P power optimizers.

³ The maximum input voltage and operating voltage upper limit will be reduced to 495 V when inverter connects and works with LG battery.

⁴ 2,500 W @ 5kWh HUAWEI ESS battery

⁵ AS4777: 4990W, ⁶ AS4777: 4990VA, ⁷ AS4777: 21.7A.